

112
年度

政府機關辦公家具採購總覽

招標案號-LP5-112021

豪優實業有限公司

地址：台北市文山區景福街230巷14號

電話：(02)29339583 傳真：(02)29350132

E-mail：hawjou@hawjou.com.tw

網址：hawjou.com.tw ergohuman.com.tw

契約編號 23-LP5-02903

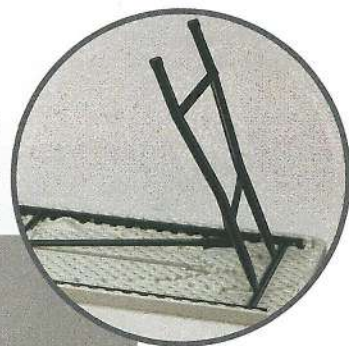
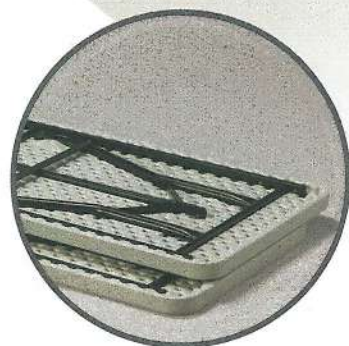

QUALITY



折合式會議桌(塑鋼桌面)

◆ W1830xD610xH740(mm) 重量：12kg±0.5KG

◆ W1830xD760xH740(mm) 重量：13.5kg±0.5KG

PERFECT DESIGN



榮獲經濟部檢驗局
ISO-9001認證



榮獲經濟部檢驗局
正字標記



榮獲全國績優廠商
特優商號



鎖具裝置開關文字及顏色顯示功能，鎖差600種變化，可變動抽換鎖心。
前擋板出線孔附塑膠保護套。
抽屜上方裝置兩只塑膠導正護片，大中抽屜具有暗卡裝置。
層身兩側加裝塑膠護片。



1-1 雙邊辦公桌(左三層右三層)
W1600xD700xH740(mm)
NT \$ 6234
◆訂購數量限1張(含)以上，300張(含)以下



1-2 雙邊辦公桌(左二層右三層)
W1600xD800xH740(mm)
NT \$ 6705
◆訂購數量限1張(含)以上，300張(含)以下



1-7 L型辦公桌(附三抽式側邊桌)
W1600xD700xH740(mm)
NT \$ 7491
◆訂購數量限1張(含)以上，300張(含)以下



1-3 雙邊辦公桌(左三層右三層)
W1400xD700xH740(mm)
NT \$ 6142
◆訂購數量限1張(含)以上，300張(含)以下



1-4 雙邊辦公桌(左二層右三層)
W1400xD700xH740(mm)
NT \$ 6103
◆訂購數量限1張(含)以上，300張(含)以下



1-8 L型辦公桌(附開門式側邊桌)
W1500xD700xH740(mm)
NT \$ 7076
◆訂購數量限1張(含)以上，300張(含)以下



1-5 單邊三抽屜辦公桌(右三層)
W1200xD700xH740(mm)
NT \$ 4261
◆訂購數量限1張(含)以上，300張(含)以下



1-6 單邊三抽屜辦公桌(右三層)
W1000xD700xH740(mm)
NT \$ 4234
◆訂購數量限1張(含)以上，300張(含)以下



1-9 L型辦公桌(附三抽式側邊桌)
W1400xD700xH740(mm)
NT \$ 7162
◆訂購數量限1張(含)以上，300張(含)以下



1-10 桌邊桌辦公桌(三層)
W420xD800xH740(mm)
NT \$ 2680
◆訂購數量限1張(含)以上，200張(含)以下



1-11 桌邊桌辦公桌(三層)
W420xD700xH740(mm)
NT \$ 2654
◆訂購數量限1張(含)以上，200張(含)以下



3-48 高活動櫃
W400xD600xH650(mm)
NT \$ 2171
◆訂購數量限1組(含)以上，200組(含)以下



3-49 矮活動櫃
W400xD600xH570(mm)
NT \$ 2171
◆訂購數量限1組(含)以上，200組(含)以下

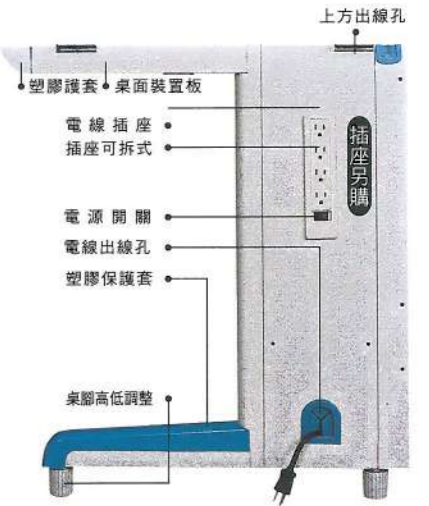

1-12 電腦辦公桌(附二只抽屜)
W1600xD700xH740(mm)
NT \$ 3573
◆訂購數量限1張(含)以上，200張(含)以下



1-13 電腦辦公桌(附二只抽屜)
W1400xD700xH740(mm)
NT \$ 3295
◆訂購數量限1張(含)以上，200張(含)以下



1-14 電腦辦公桌(附二只抽屜)
W1200xD700xH740(mm)
NT \$ 3107
◆訂購數量限1張(含)以上，200張(含)以下



1-15 全套式電腦辦公桌
W1200xD700xH740(mm)
NT \$ 4074
◆訂購數量限1張(含)以上，200張(含)以下



1-16 電腦辦公桌(附一只抽屜)
W700xD700xH740(mm)
NT \$ 2232
◆訂購數量限1張(含)以上，200張(含)以下



1-17 OA-100辦公桌(附一只ABS鍵盤架)
W1000xD700xH740(mm)
NT \$ 2321
◆訂購數量限1張(含)以上，100張(含)以下



1-18 OA-120辦公桌(附一只ABS鍵盤架)
W1200xD700xH740(mm)
NT \$ 2363
◆訂購數量限1張(含)以上，100張(含)以下



1-19 OA-140辦公桌(附一只ABS鍵盤架)
W1400xD700xH740(mm)
NT \$ 2485
◆訂購數量限1張(含)以上，100張(含)以下



1-20 OA-150辦公桌(附一只ABS鍵盤架)
W1500xD700xH740(mm)
NT \$ 2624
◆訂購數量限1張(含)以上，100張(含)以下



1-21 OA-160辦公桌(附一只ABS鍵盤架)
W1600xD700xH740(mm)
NT \$ 2788
◆訂購數量限1張(含)以上，100張(含)以下

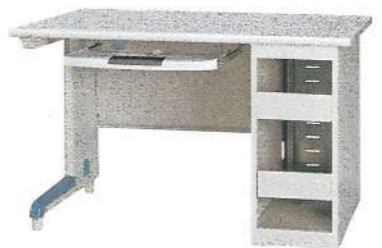

1-22 防盜式個人教學電腦辦公桌
W1200xD700xH740(mm)
NT \$ 3431
◆訂購數量限1張(含)以上，300張(含)以下



1-23 防盜式雙人教學電腦辦公桌
W1800xD700xH740(mm)
NT \$ 4479
◆訂購數量限1張(含)以上，300張(含)以下



3-41 活動電腦主機架
W285xD265xH210(mm)
NT \$ 244
◆訂購數量限1組(含)以上，100組(含)以下

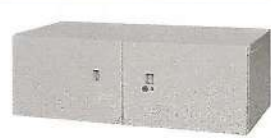

3-5 雙開門上置式鋼製公文櫃
W900xD450xH322(mm)
NT \$ 1837
◆訂購數量限1組(含)以上, 200組(含)以下



3-6 雙開門上置式鋼製公文櫃
W900xD450xH380(mm)
NT \$ 1837
◆訂購數量限1組(含)以上, 200組(含)以下



3-11 鐵拉門上置式鋼製公文櫃
W900xD450xH322(mm)
NT \$ 1713
◆訂購數量限1組(含)以上, 200組(含)以下



3-12 鐵拉門上置式鋼製公文櫃
W900xD450xH380(mm)
NT \$ 1723
◆訂購數量限1組(含)以上, 200組(含)以下

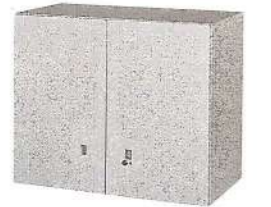

3-7 雙開門上置式鋼製公文櫃
W900xD450xH740(mm)
NT \$ 2486
◆訂購數量限1組(含)以上, 200組(含)以下



3-8 雙開門下置式鋼製公文櫃
W900xD450xH740(mm)
NT \$ 2485
◆訂購數量限1組(含)以上, 200組(含)以下



3-13 鐵拉門上置式鋼製公文櫃
W900xD450xH740(mm)
NT \$ 2303
◆訂購數量限1組(含)以上, 200組(含)以下



3-14 鐵拉門下置式鋼製公文櫃
W900xD450xH740(mm)
NT \$ 2303
◆訂購數量限1組(含)以上, 200組(含)以下



3-9 雙開門上置式鋼製公文櫃
W900xD450xH1062(mm)
NT \$ 2758
◆訂購數量限1組(含)以上, 200組(含)以下



3-10 雙開門下置式鋼製公文櫃
W900xD450xH1062(mm)
NT \$ 2758
◆訂購數量限1組(含)以上, 200組(含)以下



3-15 鐵拉門上置式鋼製公文櫃
W900xD450xH1062(mm)
NT \$ 2676
◆訂購數量限1組(含)以上, 200組(含)以下



3-16 鐵拉門下置式鋼製公文櫃
W900xD450xH1062(mm)
NT \$ 2676
◆訂購數量限1組(含)以上, 200組(含)以下



3-17 玻璃加框拉門上置式鋼製公文櫃
W900xD450xH740(mm)
NT \$ 2745
◆訂購數量限1組(含)以上, 200組(含)以下



3-18 玻璃加框拉門上置式鋼製公文櫃
W900xD450xH1062(mm)
NT \$ 2761
◆訂購數量限1組(含)以上, 200組(含)以下



3-19 複合二層式鋼製公文櫃
W900xD450xH740(mm)
NT \$ 3861
◆訂購數量限1組(含)以上, 50組(含)以下



3-20 抽屜二層式鋼製公文櫃
W900xD450xH740(mm)
NT \$ 3851
◆訂購數量限1組(含)以上, 50組(含)以下



3-21 二小一大抽屜式鋼製公文櫃
W900xD450xH740(mm)
NT \$ 4325
◆訂購數量限1組(含)以上, 50組(含)以下



3-22 四層式小抽屜鋼製公文櫃
W900xD450xH740(mm)
NT \$ 4770
◆訂購數量限1組(含)以上, 50組(含)以下



3-23 複合三層式鋼製公文櫃
W900xD450xH1062(mm)
NT \$ 4929
◆訂購數量限1組(含)以上, 50組(含)以下



3-24 抽屜三層式鋼製公文櫃
W900xD450xH1062(mm)
NT \$ 4934
◆訂購數量限1組(含)以上, 50組(含)以下



3-25 兩小兩大抽屜式鋼製公文櫃
W900xD450xH1062(mm)
NT \$ 5471
◆訂購數量限1組(含)以上, 50組(含)以下



3-26 六層式小抽屜鋼製公文櫃
W900xD450xH1062(mm)
NT \$ 6331
◆訂購數量限1組(含)以上, 50組(含)以下



3-33 雙開門密碼鎖保密公文櫃
W880xD400xH1780(mm)
NT \$ 5796
◆訂購數量限1組(含)以上, 50組(含)以下



3-35 雙開門密碼鎖保密公文櫃
W1180xD400xH1780(mm)
NT \$ 6969
◆訂購數量限1組(含)以上, 50組(含)以下



3-34 雙開門密碼鎖保密公文櫃
W1180xD400xH880(mm)
NT \$ 4408
◆訂購數量限1組(含)以上, 50組(含)以下



3-45 學生宿舍鋼製書架
W1200xD300xH950(mm)
NT \$ 1731
◆訂購數量限1組(含)以上, 200組(含)以下



3-46 學生宿舍鋼製書架
W1000xD300xH950(mm)
NT \$ 1635
◆訂購數量限1組(含)以上, 200組(含)以下



▲鋼製書架使用範例圖



3-27 公文櫃水平調整底座
W900xD435xH60(mm)
NT \$ 385
◆訂購數量限1組(含)以上, 100組(含)以下

3-28 公文櫃水平調整底座
W900xD435xH60(mm)
NT \$ 378
◆訂購數量限101組(含)以上, 500組(含)以下



3-47 公文櫃面板
W900xD450xH18(mm)
NT \$ 506
◆訂購數量限1組(含)以上, 200組(含)以下



●規格色為905色, 其他顏色另計



3-42 學生書包收納櫃
W350xD450xH350(mm)
NT \$ 785
◆訂購數量限1組(含)以上, 400組(含)以下

3-43 學生書包收納櫃
W350xD450xH350(mm)
NT \$ 775
◆訂購數量限401組(含)以上, 1600組(含)以下



3-44 學生書包收納櫃底座
W345xD450xH50(mm)
NT \$ 228
◆訂購數量限1組(含)以上, 400組(含)以下



3-29 單邊六抽屜鋼製公文櫃
W900xD450xH740(mm)
NT \$ 3694
◆訂購數量限1組(含)以上, 50組(含)以下



3-30 單邊九抽屜鋼製公文櫃
W900xD450xH1060(mm)
NT \$ 4622
◆訂購數量限1組(含)以上, 50組(含)以下



3-31 十二抽屜鋼製公文櫃
W900xD450xH740(mm)
NT \$ 4696
◆訂購數量限1組(含)以上, 50組(含)以下



3-32 十八抽屜鋼製公文櫃
W900xD450xH1060(mm)
NT \$ 5962
◆訂購數量限1組(含)以上, 50組(含)以下



▲每一手槍格附一個
20x100x70mm以上24
孔淺藍色透明壓克力之
手槍裝備彈置物盤計
54個



▲內部結構圖



▲每一手槍格附一個
20x100x70mm以上24
孔淺藍色透明壓克力之
手槍裝備彈置物盤計
27個



▲內部結構圖



▲每一手槍格附一個
20x100x70mm以上24
孔淺藍色透明壓克力之
手槍裝備彈置物盤計
36個

3-36 54格手槍櫃
W1270xD400xH1865(mm)
◆訂購數量限1組(含)以上, 50組(含)以下

3-37 27格手槍櫃
W1270xD400xH1865(mm)
◆訂購數量限1組(含)以上, 50組(含)以下

3-38 36格手槍櫃
W870xD400xH1865(mm)
◆訂購數量限1組(含)以上, 50組(含)以下



▲內部結構圖

3-39 長槍櫃
W1400xD400xH1180(mm)
◆訂購數量限1組(含)以上, 50組(含)以下

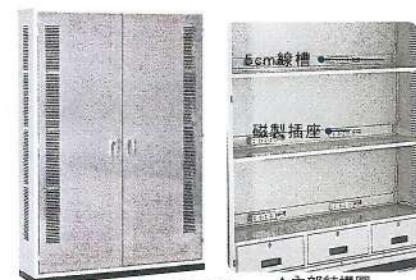

▲內部結構圖

3-40 無線電櫃
W1320xD460xH1865(mm)
◆訂購數量限1組(含)以上, 50組(含)以下



3-1 雙開門單人鋼製衣櫃
W900xD450xH1802(mm)
NT \$ 3909
◆訂購數量限1組(含)以上, 200組(含)以下



3-2 雙開門雙人鋼製衣櫃
W900xD450xH1802(mm)
NT \$ 4520
◆訂購數量限1組(含)以上, 200組(含)以下



▲雙衣櫃

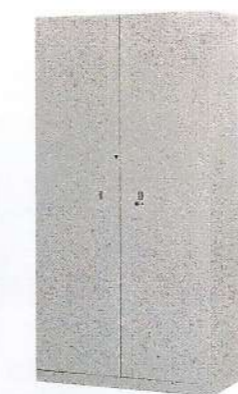

3-4 雙開門鋼製公文櫃
W900xD450xH1802(mm)
NT \$ 4633
◆訂購數量限1組(含)以上, 200組(含)以下



1-28 折合式會議桌(型鋼桌面)
W1830xD610xH740(mm)
NT \$ 2161
◆訂購數量限1張(含)以上, 300張(含)以下
重量: 12KG±0.5KG

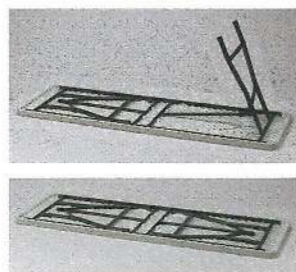

1-29 折合式會議桌(型鋼桌面)
W1830xD760xH740(mm)
NT \$ 2373
◆訂購數量限1張(含)以上, 300張(含)以下
重量: 13.5KG±0.5KG



開門效率櫃示意圖, 尺寸同
雙開門下置式鋼製公文櫃



06001
B4雙開門下置式21中抽
J-B4-T21M-AO
W900xD450xH740(mm)

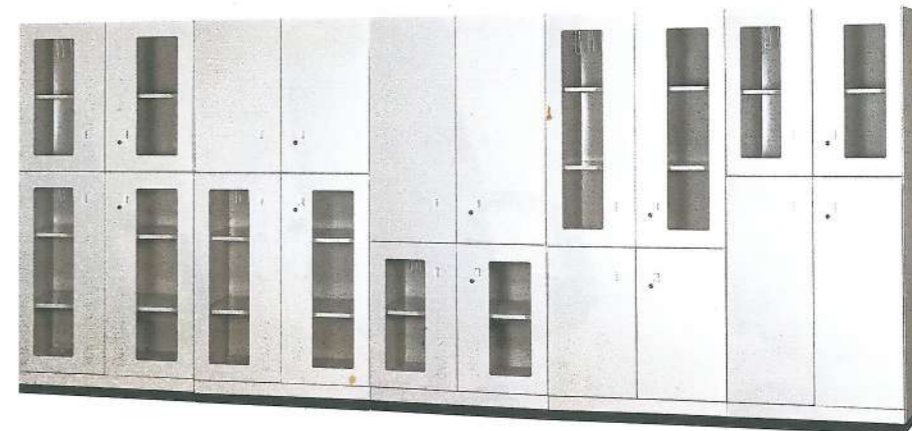

06002
B4雙開門下置式42小抽
J-B4-T42S-AO
W900xD450xH740(mm)



06003
玻璃雙開門上置式鋼製公文櫃
W900xD450xH740(mm)



06004
玻璃雙開門下置式鋼製公文櫃
W900xD450xH740(mm)



06005
B4雙開門下置式3小30中抽
J-B4-T3S30M-AO
W900xD450xH1062(mm)

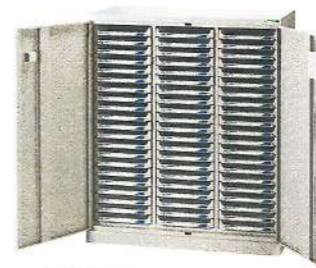

06006
B4雙開門下置式63小抽
J-B4-T63S-AO
W900xD450xH1062(mm)



06007
玻璃雙開門上置式鋼製公文櫃
W900xD450xH1062(mm)



06008
玻璃雙開門下置式鋼製公文櫃
W900xD450xH1062(mm)

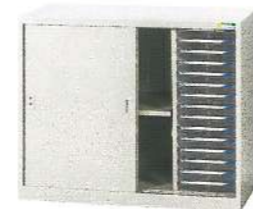

06009
A4鐵拉門邊15小抽
J-A4-O15S-US
W900xD450xH740(mm)

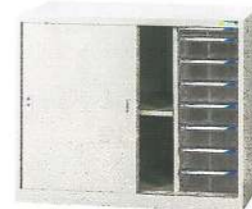

06010
A4鐵拉門邊1小7中抽
J-A4-O1S7M-US
W900xD450xH740(mm)



06011
A4鐵拉門邊22小抽
J-A4-O22S-US
W900xD450xH1062(mm)



06012
A4鐵拉門邊11中抽
J-A4-O11M-US
W900xD450xH1062(mm)



1-24 折合式會議桌(夾板桌面)
W1800xD450xH740(mm)
NT \$ 1776
◆訂購數量限1張(含)以上, 300張(含)以下



1-25 折合式會議桌(夾板桌面)
W1800xD600xH740(mm)
NT \$ 1826
◆訂購數量限1張(含)以上, 300張(含)以下



1-26 折合式會議桌(夾板桌面)
W1800xD750xH740(mm)
NT \$ 2130
◆訂購數量限1張(含)以上, 300張(含)以下



1-27 折合式會議桌(夾板桌面)
W1800xD900xH740(mm)
NT \$ 2272
◆訂購數量限1張(含)以上, 300張(含)以下



2-1 辦公椅
W770xD710xH1280-1360(mm)
NT \$ 8264
◆訂購數量限1張(含)以上, 400張(含)以下



2-2 辦公椅
W680xD750xH1160-1240(mm)
NT \$ 5435
◆訂購數量限1張(含)以上, 400張(含)以下



2-3 辦公椅
W680xD720xH1020-1100(mm)
NT \$ 5398
◆訂購數量限1張(含)以上, 400張(含)以下



2-36 會客辦公椅
W582xD630xH880(mm)
NT \$ 2257
◆訂購數量限1張(含)以上, 100張(含)以下



2-4 辦公椅
W660xD640xH1070-1150(mm)
NT \$ 7262
◆訂購數量限1張(含)以上, 400張(含)以下



2-5 辦公椅
W660xD610xH950-1030(mm)
NT \$ 6695
◆訂購數量限1張(含)以上, 400張(含)以下



2-6 辦公椅
W670xD660xH1170-1250(mm)
NT \$ 5020
◆訂購數量限1張(含)以上, 400張(含)以下



2-7 辦公椅
W670xD660xH1000-1080(mm)
NT \$ 4752
◆訂購數量限1張(含)以上, 400張(含)以下



2-17 新人體工學辦公椅
W620xD620xH1080-1160(mm)
NT \$ 2262
◆訂購數量限1張(含)以上, 400張(含)以下



2-18 新人體工學辦公椅
W620xD610xH860-940(mm)
NT \$ 2137
◆訂購數量限1張(含)以上, 400張(含)以下



2-19 新人體工學辦公椅
W510xD610xH860-940(mm)
NT \$ 1872
◆訂購數量限1張(含)以上, 400張(含)以下



2-23 電腦辦公椅
W500xD590xH890-970(mm)
NT \$ 1989
◆訂購數量限1張(含)以上, 400張(含)以下



2-11 辦公椅
W630xD595xH1150-1270(mm)
NT \$ 2291
◆訂購數量限1張(含)以上, 400張(含)以下



2-12 辦公椅
W630xD575xH910-1030(mm)
NT \$ 2029
◆訂購數量限1張(含)以上, 400張(含)以下



▲椅背採彈性網布包覆



2-13 辦公椅
W470xD575xH910-1030(mm)
NT \$ 1898
◆訂購數量限1張(含)以上, 400張(含)以下



2-14 辦公椅
W680xD600xH1110-1190(mm)
NT \$ 2408
◆訂購數量限1張(含)以上, 400張(含)以下



2-8 辦公椅
W620xD630xH1180-1260(mm)
NT \$ 3077
◆訂購數量限1張(含)以上, 400張(含)以下



2-9 辦公椅
W620xD570xH970-1050(mm)
NT \$ 2927
◆訂購數量限1張(含)以上, 400張(含)以下



2-10 辦公椅
W510xD570xH970-1050(mm)
NT \$ 2733
◆訂購數量限1張(含)以上, 400張(含)以下



2-15 辦公椅
W680xD600xH870-955(mm)
NT \$ 2169
◆訂購數量限1張(含)以上, 400張(含)以下



2-20 人體工學辦公椅
W630xD610xH1100-1180(mm)
NT \$ 1938
◆訂購數量限1張(含)以上, 400張(含)以下



2-21 人體工學辦公椅
W630xD610xH920-1000(mm)
NT \$ 1783
◆訂購數量限1張(含)以上, 400張(含)以下



2-22 人體工學辦公椅
W510xD610xH920-1000(mm)
NT \$ 1665
◆訂購數量限1張(含)以上, 400張(含)以下



2-16 辦公椅
W490xD600xH870-955(mm)
NT \$ 1834
◆訂購數量限1張(含)以上, 400張(含)以下



08001 豪門新型單人課椅
W540xD570xH830(mm)



08002 翡翠迷你椅(烤黑)
W410xD460xH795(mm)



08003 翡翠迷你椅(烤銀)
W410xD460xH795(mm)



08004 鑽石迷你椅(電鍍)
W480xD530xH795(mm)



08005 單人椅(藍色XFO5)(可疊式)
W482xD610xH810(mm)



▲椅座左右加公母扣設計，增加連結功能方便排列規劃整理。



2-24 人體工學塑鋼摺合椅
W465xD525xH775(mm)
NT \$ 440
◆訂購數量限1張(含)以上，400張(含)以下



2-26 塑鋼摺合椅
W460xD520xH765(mm)
NT \$ 400
◆訂購數量限1張(含)以上，400張(含)以下



2-28 鋼製摺合椅
W425xD485xH795(mm)
NT \$ 395
◆訂購數量限1張(含)以上，400張(含)以下



2-35 禮堂、視聽連結座椅(單人份)
W580xD870xH940-990(mm)
NT \$ 3097
◆訂購數量限1張(含)以上，400張(含)以下

2-25 人體工學塑鋼摺合椅
W465xD525xH775(mm)
NT \$ 435
◆訂購數量限401張(含)以上，1600張(含)以下

2-27 塑鋼摺合椅
W460xD520xH765(mm)
NT \$ 395
◆訂購數量限401張(含)以上，1600張(含)以下

2-29 鋼製摺合椅
W425xD485xH795(mm)
NT \$ 385
◆訂購數量限401張(含)以上，1600張(含)以下



本公司課桌椅榮獲經濟部檢驗局正字標記



1-30 學生可調昇降課桌
W610xD420xH750(mm)
NT \$ 870
◆訂購數量限1張(含)以上，400張(含)以下



2-30 學生可調昇降課椅
W450xD470xH770(mm)
NT \$ 810
◆訂購數量限1張(含)以上，400張(含)以下



1-32 新型學生可調昇降課桌
W595xD425xH710-810(mm)
NT \$ 870
◆訂購數量限1張(含)以上，400張(含)以下



2-37 新型學生可調昇降課椅
W460xD485xH740-840(mm)
NT \$ 891
◆訂購數量限1張(含)以上，400張(含)以下

1-31 學生可調昇降課桌
W610xD420xH750(mm)
NT \$ 860
◆訂購數量限401張(含)以上，1600張(含)以下

2-31 學生可調昇降課椅
W450xD470xH770(mm)
NT \$ 800
◆訂購數量限401張(含)以上，1600張(含)以下

1-33 新型學生可調昇降課桌
W595xD425xH710-810(mm)
NT \$ 860
◆訂購數量限401張(含)以上，1600張(含)以下

2-38 新型學生可調昇降課椅
W460xD485xH740-840(mm)
NT \$ 876
◆訂購數量限401張(含)以上，1600張(含)以下



2-32 學生單人連結課桌椅
W610xD940xH750(mm)
NT \$ 1235
◆訂購數量限1張(含)以上，400張(含)以下



2-33 學生單人課桌椅
W530xD750xH720(mm)
NT \$ 1113
◆訂購數量限1張(含)以上，100張(含)以下



2-34 視聽教室連結課桌椅
W1120xD600xH820(mm)
NT \$ 3391
◆訂購數量限1組(含)以上，100組(含)以下



2-43 新型學生單人固定課桌椅
W550xD770xH850(mm)
NT \$ 2045
◆訂購數量限1張(含)以上，100張(含)以下



2-39 新型學生單人連結課桌椅
W595xD910xH830(mm)
NT \$ 1389
◆訂購數量限1張(含)以上，400張(含)以下



2-40 新型學生單人課桌椅
W660xD815xH830(mm)
NT \$ 1179
◆訂購數量限1張(含)以上，200張(含)以下



2-41 新型二人視聽教室連結課桌椅
W1300xD564xH825(mm)
NT \$ 3421
◆訂購數量限1張(含)以上，100張(含)以下



2-42 新型三人視聽教室連結課桌椅
W1780xD564xH825(mm)
NT \$ 5162
◆訂購數量限1張(含)以上，100張(含)以下



3-50 3連5層移動櫃(不含軌道)
W582xD2915xH2174(mm)
◆訂購數量限1組(含)以上，15組(含)以下

3-52 3連5層移動櫃(不含軌道)
W662xD2915xH2174(mm)
◆訂購數量限1組(含)以上，15組(含)以下



3-54 4連5層移動櫃(不含軌道)
W582xD3815xH2174(mm)
◆訂購數量限1組(含)以上，15組(含)以下

3-56 4連5層移動櫃(不含軌道)
W662xD3815xH2174(mm)
◆訂購數量限1組(含)以上，15組(含)以下

3-51 3連5層移動櫃(不含軌道)
W582xD2915xH2354(mm)
◆訂購數量限1組(含)以上，15組(含)以下

3-53 3連5層移動櫃(不含軌道)
W662xD2915xH2354(mm)
◆訂購數量限1組(含)以上，15組(含)以下

3-55 4連5層移動櫃(不含軌道)
W582xD3815xH2354(mm)
◆訂購數量限1組(含)以上，15組(含)以下

3-57 4連5層移動櫃(不含軌道)
W662xD3815xH2354(mm)
◆訂購數量限1組(含)以上，15組(含)以下



3-58 5連5層移動櫃(不含軌道)
W582xD4715xH2174(mm)
◆訂購數量限1組(含)以上，15組(含)以下

3-60 5連5層移動櫃(不含軌道)
W662xD4715xH2174(mm)
◆訂購數量限1組(含)以上，15組(含)以下

3-59 5連5層移動櫃(不含軌道)
W582xD4715xH2354(mm)
◆訂購數量限1組(含)以上，15組(含)以下

3-61 5連5層移動櫃(不含軌道)
W662xD4715xH2354(mm)
◆訂購數量限1組(含)以上，15組(含)以下



3-62 防傾倒軌道組
◆訂購數量限1米(含)以上，300米(含)以下

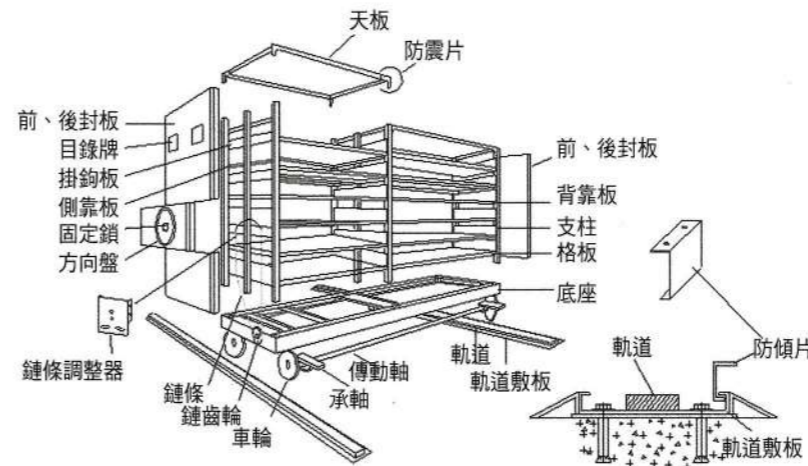

超大容量 配置靈活 單連或多連組櫃皆可配合空間規劃利用耐用堅固、安全實用，可儲放大量不同類型的檔案資料，適用於公司號、機關學校、團體使用。
軌道式及轉盤手把設計，節省您不必要的人力浪費，標示牌裝置更節省您找尋檔案時的時間浪費。

規格、尺寸、材質，原廠有協助規劃、設計、組裝。

輕量型固定式





4-1 25mm屏風
NT \$ 1870
◆訂購數量限1米平方(含)以上, 300米平方(含)以下

4-2 25mm屏風
NT \$ 1842
◆訂購數量限300.01米平方(含)以上, 800米平方(含)以下

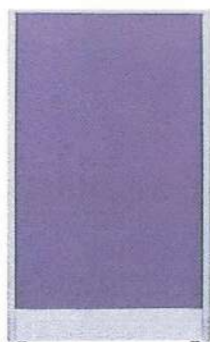

4-3 52mm鋼製屏風
NT \$ 1822
◆訂購數量限1米平方(含)以上, 300米平方(含)以下



4-4 屏風桌板
NT \$ 1351
◆訂購數量限1米平方(含)以上, 300米平方(含)以下

4-4 屏風走線槽
NT \$ 418
◆訂購數量限1米(含)以上, 300米(含)以下



11001 木紋中抽(905)
W54xD40xH11(cm)

11002 鐵中抽(加鎖)
W54xD40xH11(cm)



11003 ABS鍵盤
W56xD40xH9(cm)



11004 F把手中抽(905)
W54xD40xH11(cm)

11005 F把手中抽(深灰)
W54xD40xH11(cm)

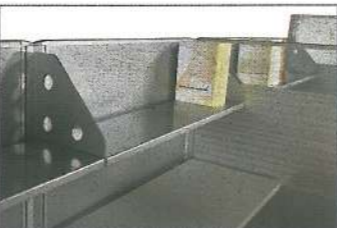

11006 2.5cm屏風書架

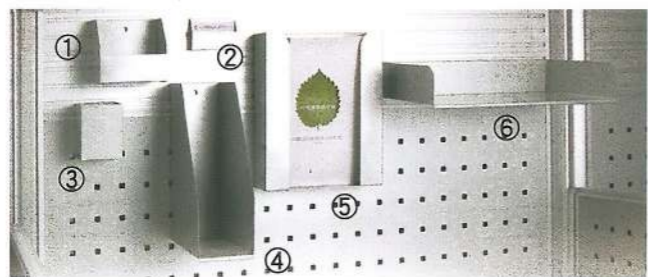

11007
①CD架 ②名片架 ③筆筒架
④資料架 ⑤雜誌架 ⑥文件架



11008 2.5cm屏風三角線槽



12001 實驗桌
W180xD70xH74.5(cm)



實驗椅面為皮面, 包覆泡綿



收納圖

12002 實驗椅
W35xD30xH45(cm)



12003 圓型木紋會議桌(木紋腳)(加框)
W180xD90xH74(cm)

12004 圓型木紋會議桌(木紋腳)(加框)
W240xD120xH74(cm)



12005 圓型胡桃會議桌(胡桃腳)(加框)
W180xD90xH74(cm)

12006 圓型胡桃會議桌(胡桃腳)(加框)
W240xD120xH74(cm)



12007 船型會議桌(電鍍腳)(加框)
W180xD90xH74(cm)

12008 船型會議桌(電鍍腳)(加框)
W240xD120xH74(cm)



12009 會議桌(整組)(不含椅子)
W320xD160xH75(cm)



12010 木紋會議桌(整組)(不含椅子)
W300xD300xH75(cm)



12011 木紋會議桌(整組)(不含椅子)
W300xH75(cm)



12012 會議桌(整組)(不含椅子)
W300xD300xH75(cm)

本頁產品採用高級PU輪，靜音、防滑、防刮



第一代-按壓式



前擋板可更改為洞洞板



胡桃色掀合會議桌(掛式前擋)

- 13001 W120xD45xH75(cm)
- 13002 W120xD60xH75(cm)
- 13003 W180xD45xH75(cm)
- 13004 W180xD60xH75(cm)



木紋色掀合會議桌(掛式前擋)

- 13005 W120xD45xH75(cm)
- 13006 W120xD60xH75(cm)
- 13007 W180xD45xH75(cm)
- 13008 W180xD60xH75(cm)



905色掀合會議桌(掛式前擋)

- 13009 W120xD45xH75(cm)
- 13010 W120xD60xH75(cm)
- 13011 W180xD45xH75(cm)
- 13012 W180xD60xH75(cm)



13013 胡桃色掀合轉角桌(掛式前擋)
1/4 70RxD60xH75(cm)



13014 木紋色掀合轉角桌(掛式前擋)
1/4 70RxD60xH75(cm)



掀合桌收折流程表



13015 905色掀合轉角桌(掛式前擋)
1/4 70RxD60xH75(cm)



整齊劃一的收納方式，讓空間多更多，使用更便利



轉角桌也可掀合收納，空間組合多元

採用高級PU輪，靜音、防滑、防刮



移動輪另附水平調整鈕，會議桌結合平整、穩固

本頁產品採用高級PU輪，靜音、防滑、防刮



第二代-把手型



洞洞板可更改為木質擋板



905擋板

木紋擋板

胡桃擋板



胡桃色掀合會議桌(洞洞板)

- 14001 W120xD45xH75(cm)
- 14002 W120xD60xH75(cm)
- 14003 W180xD45xH75(cm)
- 14004 W180xD60xH75(cm)



木紋色掀合會議桌(洞洞板)

- 14005 W120xD45xH75(cm)
- 14006 W120xD60xH75(cm)
- 14007 W180xD45xH75(cm)
- 14008 W180xD60xH75(cm)



905色掀合會議桌(洞洞板)

- 14009 W120xD45xH75(cm)
- 14010 W120xD60xH75(cm)
- 14011 W180xD45xH75(cm)
- 14012 W180xD60xH75(cm)



採用高級PU輪，靜音、防滑、防刮



14013 胡桃色掀合轉角桌
1/4 70RxD60xH75(cm)



14014 木紋色掀合轉角桌
1/4 70RxD60xH75(cm)



14015 905色掀合轉角桌
1/4 70RxD60xH75(cm)

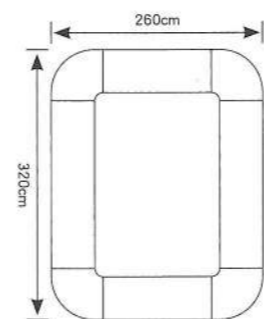

組合示意圖1

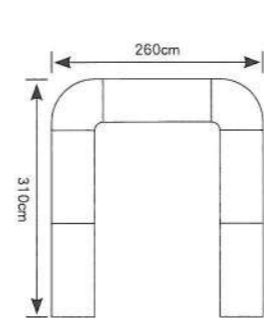

組合示意圖2

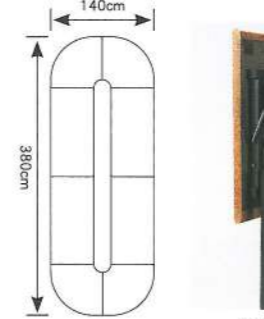

組合示意圖3



氣壓式折合機關



收合示意圖



整齊劃一的收納方式，讓空間多更多，使用更便利

此木紋為鋼板熱烤轉印非一般市售印刷木紋，兩者相較熱烤方式比印刷方式較耐溶劑擦拭且較不易退色



15001
L型辦公桌(木紋面)(附三抽式側邊桌)
W1600xD700xH740(mm)



15002
雙邊辦公桌(木紋面)(左三層右三層)
W1600xD700xH740(mm)



15003
L型辦公桌(木紋面)(附開門式側邊桌)
W1500xD700xH740(mm)



15004
雙邊辦公桌(木紋面)(左二層右三層)
W1600xD800xH740(mm)



15005
L型辦公桌(木紋面)(附三抽式側邊桌)
W1400xD700xH740(mm)



15006
雙邊辦公桌(木紋面)(左三層右三層)
W1400xD700xH740(mm)



15007
單邊三抽屜辦公桌(木紋面)(右三層)
W1200xD700xH740(mm)



15008
單邊三抽屜辦公桌(木紋面)(右三層)
W1000xD700xH740(mm)



15009
雙邊辦公桌(木紋面)(左二層右三層)
W1400xD700xH740(mm)



16001
電腦辦公桌(木紋面)(附一只抽屜)
W700xD700xH740(mm)



16002
電腦辦公桌(木紋面)(附二只抽屜)
W1200xD700xH740(mm)



16004
電腦辦公桌(木紋面)(附二只抽屜)
W1600xD700xH740(mm)



16005
OA-100辦公桌(木紋面)(附一只ABS鍵盤架)
W1000xD700xH740(mm)



16006
OA-120辦公桌(木紋面)(附一只ABS鍵盤架)
W1200xD700xH740(mm)



16008
OA-150辦公桌(木紋面)(附一只ABS鍵盤架)
W1500xD700xH740(mm)



16010
防盜式個人教學電腦辦公桌(木紋面)
W1200xD700xH740(mm)



16011
防盜式雙人教學電腦辦公桌(木紋面)
W1800xD700xH740(mm)



16012
矮活動櫃(木紋面)
W400xD600xH570(mm)



16013
全套式電腦辦公桌(木紋面)
W1200xD700xH740(mm)



16014
桌邊桌辦公桌(木紋面)(三層)
W420xD800xH740(mm)



16015
桌邊桌辦公桌(木紋面)(三層)
W420xD700xH740(mm)



16016
高活動櫃(木紋面)
W400xD600xH650(mm)

此木紋為鋼板熱烤轉印非一般市售印刷木紋，兩者相較熱烤方式比印刷方式較耐溶劑擦拭且較不易退色



17001
雙邊辦公桌(胡桃面)(左三層右三層)
W1600xD700xH740(mm)



17002
雙邊辦公桌(胡桃面)(左三層右三層)
W1400xD700xH740(mm)



17003
桌邊桌辦公桌(胡桃面)(三層)
W420xD800xH740(mm)



17004
雙邊辦公桌(胡桃面)(左二層右三層)
W1600xD800xH740(mm)



17005
雙邊辦公桌(胡桃面)(左二層右三層)
W1400xD700xH740(mm)



17006
桌邊桌辦公桌(胡桃面)(三層)
W420xD700xH740(mm)



17007
L型辦公桌(胡桃面)(附三抽式側邊桌)
W1600xD700xH740(mm)



17008
高活動櫃(胡桃面)
W400xD600xH650(mm)



17009
矮活動櫃(胡桃面)
W400xD600xH570(mm)



17010
L型辦公桌(胡桃面)(附開門式側邊桌)
W1500xD700xH740(mm)



17011
L型辦公桌(胡桃面)(附三抽式側邊桌)
W1400xD700xH740(mm)



18001
單邊三抽屜辦公桌(胡桃面)(右三層)
W1200xD700xH740(mm)



18002
單邊三抽屜辦公桌(胡桃面)(右三層)
W1000xD700xH740(mm)



18003
全套式電腦辦公桌(胡桃面)
W1200xD700xH740(mm)



18004
電腦辦公桌(胡桃面)(附一只抽屜)
W700xD700xH740(mm)



18005
電腦辦公桌(胡桃面)(附二只抽屜)
W1200xD700xH740(mm)



18007
電腦辦公桌(胡桃面)(附二只抽屜)
W1600xD700xH740(mm)

18006
電腦辦公桌(胡桃面)(附二只抽屜)
W1400xD700xH740(mm)



18008
OA-100辦公桌(胡桃面)(附一只ABS鍵盤架)
W1000xD700xH740(mm)



18009
OA-120辦公桌(胡桃面)(附一只ABS鍵盤架)
W1200xD700xH740(mm)



18011
OA-150辦公桌(胡桃面)(附一只ABS鍵盤架)
W1500xD700xH740(mm)

18010
OA-140辦公桌(胡桃面)(附一只ABS鍵盤架)
W1400xD700xH740(mm)

18012
OA-160辦公桌(胡桃面)(附一只ABS鍵盤架)
W1600xD700xH740(mm)



18013
防盜式個人教學電腦辦公桌(胡桃面)
W1200xD700xH740(mm)



18014
防盜式雙人教學電腦辦公桌(胡桃面)
W1800xD700xH740(mm)

此木紋為鋼板熱烤轉印非一般市售印刷木紋，兩者相較熱烤方式比印刷方式較耐溶劑擦拭且較不易退色

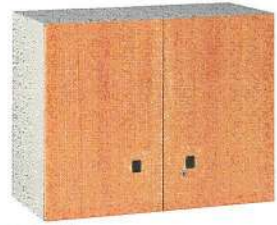

19001
雙開門上置式鋼製公文櫃(木紋面)
W900xD450xH740(mm)



19002
雙開門下置式鋼製公文櫃(木紋面)
W900xD450xH740(mm)

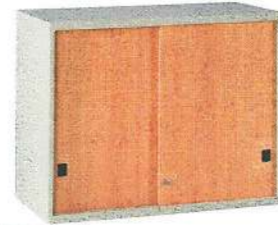

19003
鐵拉門上置式鋼製公文櫃(木紋面)
W900xD450xH740(mm)

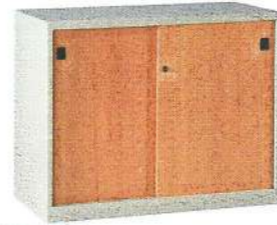

19004
鐵拉門下置式鋼製公文櫃(木紋面)
W900xD450xH740(mm)



19005
雙開門上置式鋼製公文櫃(木紋面)
W900xD450xH1062(mm)

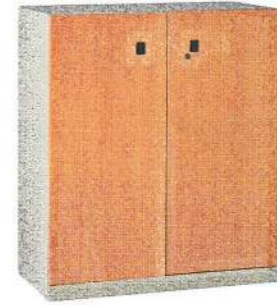

19006
雙開門下置式鋼製公文櫃(木紋面)
W900xD450xH1062(mm)



19007
鐵拉門上置式鋼製公文櫃(木紋面)
W900xD450xH1062(mm)



19008
鐵拉門下置式鋼製公文櫃(木紋面)
W900xD450xH1062(mm)



19009
複合二層式鋼製公文櫃(木紋面)
W900xD450xH740(mm)



19010
抽屜二層式鋼製公文櫃(木紋面)
W900xD450xH740(mm)



19011
兩小一大抽屜鋼製公文櫃(木紋面)
W900xD450xH740(mm)



19012
四層式小抽屜鋼製公文櫃(木紋面)
W900xD450xH740(mm)



19013
複合三層式鋼製公文櫃(木紋面)
W900xD450xH1062(mm)



19014
抽屜三層式鋼製公文櫃(木紋面)
W900xD450xH1062(mm)



19015
兩大兩小抽屜鋼製公文櫃(木紋面)
W900xD450xH1062(mm)



19016
六層式小抽屜鋼製公文櫃(木紋面)
W900xD450xH1062(mm)

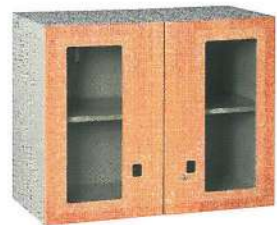

19017
玻璃雙開門上置式鋼製公文櫃(木紋面)
W900xD450xH740(mm)



19018
玻璃雙開門下置式鋼製公文櫃(木紋面)
W900xD450xH740(mm)



19019
玻璃雙開門上置式鋼製公文櫃(木紋面)
W900xD450xH1062(mm)



19020
玻璃雙開門下置式鋼製公文櫃(木紋面)
W900xD450xH1062(mm)



20001
雙開門上置式鋼製公文櫃(胡桃面)
W900xD450xH740(mm)



20002
雙開門下置式鋼製公文櫃(胡桃面)
W900xD450xH740(mm)



20003
鐵拉門上置式鋼製公文櫃(胡桃面)
W900xD450xH740(mm)



20004
鐵拉門下置式鋼製公文櫃(胡桃面)
W900xD450xH740(mm)



20005
雙開門上置式鋼製公文櫃(胡桃面)
W900xD450xH1062(mm)



20006
雙開門下置式鋼製公文櫃(胡桃面)
W900xD450xH1062(mm)



20007
鐵拉門上置式鋼製公文櫃(胡桃面)
W900xD450xH1062(mm)



20008
鐵拉門下置式鋼製公文櫃(胡桃面)
W900xD450xH1062(mm)



20009
複合二層式鋼製公文櫃(胡桃面)
W900xD450xH740(mm)



20010
抽屜二層式鋼製公文櫃(胡桃面)
W900xD450xH740(mm)



20011
兩小一大抽屜鋼製公文櫃(胡桃面)
W900xD450xH740(mm)



20012
四層式小抽屜鋼製公文櫃(胡桃面)
W900xD450xH740(mm)



20013
複合三層式鋼製公文櫃(胡桃面)
W900xD450xH1062(mm)



20014
抽屜三層式鋼製公文櫃(胡桃面)
W900xD450xH1062(mm)



20015
兩大兩小抽屜鋼製公文櫃(胡桃面)
W900xD450xH1062(mm)



20016
六層式小抽屜鋼製公文櫃(胡桃面)
W900xD450xH1062(mm)



20017
玻璃雙開門上置式鋼製公文櫃(胡桃面)
W900xD450xH740(mm)



20018
玻璃雙開門下置式鋼製公文櫃(胡桃面)
W900xD450xH740(mm)



20019
玻璃雙開門上置式鋼製公文櫃(胡桃面)
W900xD450xH1062(mm)



20020
玻璃雙開門下置式鋼製公文櫃(胡桃面)
W900xD450xH1062(mm)

此木紋為鋼板熱烤轉印非一般市售印刷木紋，兩者相較熱烤方式比印刷方式較耐溶劑擦拭且較不易退色

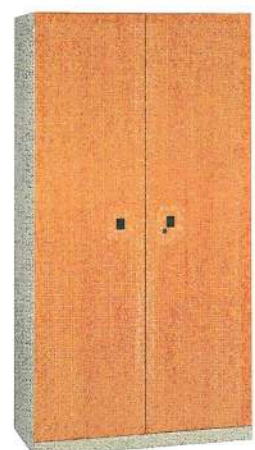

內視圖



內視圖



21002
雙開門雙人鋼製衣櫃(木紋面)
W900xD450xH1802(mm)

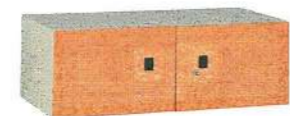

21003
雙開門上置式鋼製公文櫃(木紋面)
W900xD450xH322(mm)



21004
鐵拉門上置式鋼製公文櫃(木紋面)
W900xD450xH322(mm)

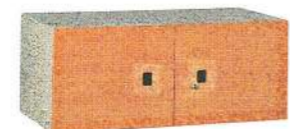

21005
雙開門上置式鋼製公文櫃(木紋面)
W900xD450xH380(mm)

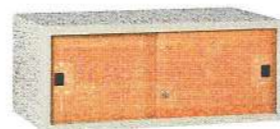

21006
鐵拉門上置式鋼製公文櫃(木紋面)
W900xD450xH380(mm)

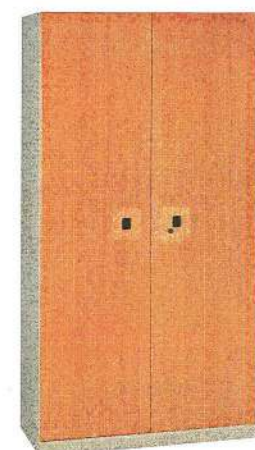

21007
雙開門鋼製公文櫃(木紋面)
W900xD450xH1802(mm)



內視圖



內視圖

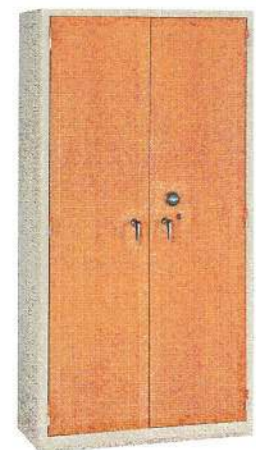

21008
雙開門密碼鎖保密公文櫃(木紋面)
W880xD400xH1780(mm)

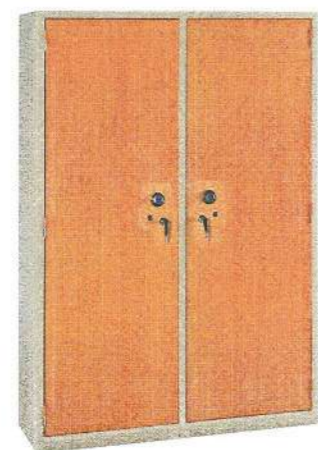

21009
雙開門密碼鎖保密公文櫃(木紋面)
W1180xD400xH1780(mm)



21010
學生書包收納櫃(木紋面)
W350xD450xH350(mm)

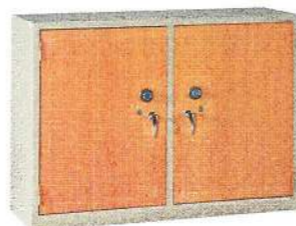

21011
雙開門密碼鎖保密公文櫃(木紋面)
W1180xD400xH880(mm)



21012
玻璃加框拉門上置式鋼製公文櫃(木紋面)
W900xD450xH740(mm)



21013
玻璃加框拉門上置式鋼製公文櫃(木紋面)
W900xD450xH1062(mm)



22001
雙開門上置式鋼製公文櫃(胡桃面)
W900xD450xH322(mm)



22002
鐵拉門上置式鋼製公文櫃(胡桃面)
W900xD450xH380(mm)



22003
鐵拉門上置式鋼製公文櫃(胡桃面)
W900xD450xH322(mm)



22004
鐵拉門上置式鋼製公文櫃(胡桃面)
W900xD450xH380(mm)



22005
雙開門密碼鎖保密公文櫃(胡桃面)
W880xD400xH1780(mm)



內視圖



內視圖

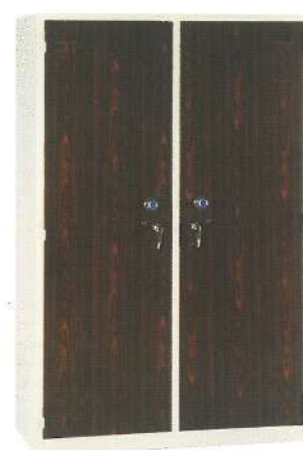

22006
雙開門密碼鎖保密公文櫃(胡桃面)
W1180xD400xH1780(mm)



22007
雙開門鋼製公文櫃(胡桃面)
W900xD450xH1802(mm)



內視圖



內視圖



22008
雙開門單人鋼製衣櫃(胡桃面)
W900xD450xH1802(mm)



內視圖



內視圖



22009
雙開門雙人鋼製衣櫃(胡桃面)
W900xD450xH1802(mm)



22010
雙開門密碼鎖保密公文櫃(胡桃面)
W1180xD400xH880(mm)



22012
學生書包收納櫃(胡桃面)
W350xD450xH350(mm)



22011
玻璃加框拉門上置式鋼製公文櫃(胡桃面)
W900xD450xH740(mm)



22013
玻璃加框拉門上置式鋼製公文櫃(胡桃面)
W900xD450xH1062(mm)



23001 鋼木書櫃
W90xD47xH74(cm)



23002 鋼木書櫃
W90xD47xH74(cm)



23005 鋼木書櫃
W90xD47xH32(cm)



23006 鋼木玻璃書櫃
W90xD47xH74(cm)



23007 鋼木玻璃書櫃
W90xD47xH106(cm)



23003 鋼木書櫃
W90xD47xH74(cm)



23004 鋼木書櫃
W90xD47xH74(cm)



23008 鋼木書櫃
W90xD47xH106(cm)



23009 鋼木書櫃
W90xD47xH106(cm)



23010 鋼木書櫃
W90xD47xH106(cm)



23011 鋼木書櫃
W90xD47xH106(cm)



23012 鋼木玻璃書櫃
W90xD47xH74(cm)



23013 鋼木玻璃書櫃
W90xD47xH106(cm)

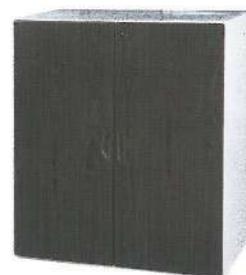

23014 鋼木書櫃
W90xD47xH106(cm)



23015 鋼木書櫃
W90xD47xH106(cm)



23016 鋼木書櫃
W90xD47xH106(cm)



23017 鋼木書櫃
W90xD47xH106(cm)



23018 鋼木書櫃
W90xD47xH74(cm)



23019 鋼木書櫃
W90xD47xH74(cm)



23020 鋼木書櫃
W90xD47xH74(cm)



23021 鋼木書櫃
W90xD47xH74(cm)



23022 鋼木書櫃
W90xD47xH32(cm)

全開式開啟
方便收藏



▲內部結構圖

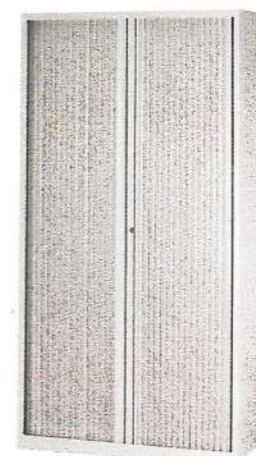

24001 捲門公文櫃
W90xD45xH180(cm)



24002 捲門公文櫃
W118xD45xH74(cm)

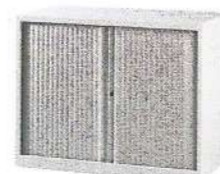

24003 捲門公文櫃
W90xD45xH74(cm)

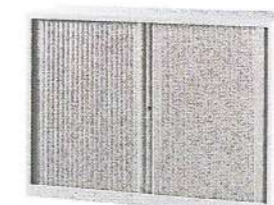

24004 捲門公文櫃
W118xD45xH90(cm)



24005 捲門公文櫃
W90xD45xH106(cm)

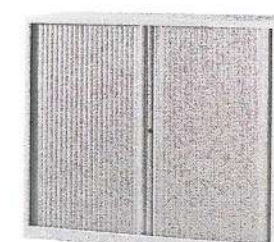

24006 捲門公文櫃
W118xD45xH106(cm)

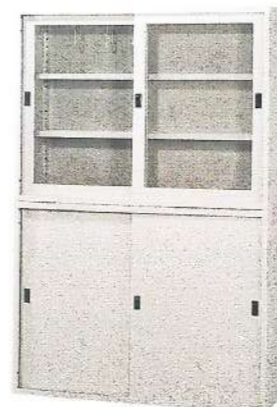

24007 鐵拉門(4x6整組)
W118xD40xH176(cm)



24008 連座書櫃(4x6有中隔)
W118xD40xH178(cm)

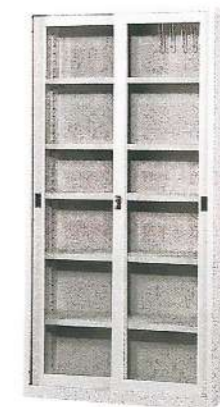

24009 連座書櫃(3x6)
W88xD40xH178(cm)



24010 連座書櫃(4x6)
W118xD40xH178(cm)

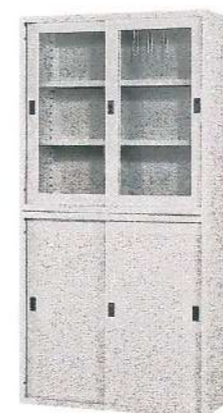

24011 鐵拉門(3x6整組)
W88xD40xH176(cm)



24012 鐵拉門(6x6整組)上座有中隔
W176xD40x高176(cm)



24013 30格手機櫃
W97xD35xH112.5(cm)

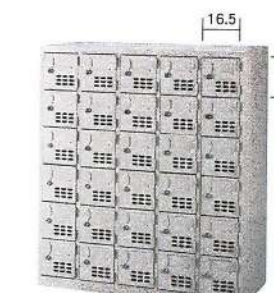

24014 30格手機櫃
W97xD35xH112.5(cm)



此木紋為鋼板熱烤轉印非一般市售印刷木紋，兩者相較熱烤方式比印刷方式較耐溶劑擦拭且較不易退色



27001 101沙發組(1+2+3人)

單人沙發
W72xD69.5xH77(cm)
雙人沙發
W128xD69.5xH77(cm)
三人沙發
W184xD69.5xH77(cm)
2012大茶几
W127xD67xH52(cm)
2012小茶几
W 67xD67xH52(cm)



27002 102 L型沙發組

W236xD180xH77(cm)
101單人輔助椅
W51xD50xH38.5(cm)
101雙人輔助椅
W100xD50xH38.5(cm)
101三人輔助椅
W151xD50xH38.5(cm)
俏麗大茶几
W120xD60xH52(cm)
俏麗小茶几
W 60xD60xH52(cm)



可隨意組合

27003 103沙發組(平面黑皮)

轉角：W69xD69xSH43xH68(cm)
輔助椅：W69xD69xH43(cm)
靠背：W69xD69xSH43xH68(cm)
俏麗大茶几
W120xD60xH52(cm)
俏麗小茶几
W 60xD60xH52(cm)



可隨意組合



28001 103沙發組(黑皮/方格)

轉角：W69xD69xSH43xH68(cm)
輔助椅：W69xD69xH43(cm)
靠背：W69xD69xSH43xH68(cm)
俏麗大茶几
W120xD60xH52(cm)
俏麗小茶几
W 60xD60xH52(cm)



28002 溫莎沙發組(1+1+3人)

單人沙發
W64xSD48xD78xSH43xH78(cm)
三人沙發
W170xSD48xD78xSH43xH78(cm)
俏麗大茶几
W120xD60xH52(cm)
俏麗小茶几
W 60xD60xH52(cm)



28003 三管沙發組(1+1+3人)

單人沙發
W67.5xD79xH83(cm)
三人沙發
W177xD79xH83(cm)
扁管大茶几
W125xD49xH51(cm)
扁管小茶几
W 44xD49xH51(cm)

28004 小沙發

W35xSD33xD51xSH29xH55.5(cm)

29001 俏麗沙發組(1+2+3人)

單人沙發
W62.5xSD52xD69xSH39xH80(cm)
雙人沙發
W113.5xSD52xD69xSH39xH80(cm)
三人沙發
W164.5xSD52xD69xSH39xH80(cm)
溫莎大茶几
W120xD60xH51(cm)
溫莎小茶几
W 60xD60xH51(cm)



29002 吉利沙發組(1+2+3人)

單人沙發
W66.3xSD51xD79xSH42xH88(cm)
雙人沙發
W119xSD51xD79xSH42xH88(cm)
三人沙發
W171xSD51xD79xSH42xH88(cm)
吉利鋼管大茶几
W120xD60xH51(cm)
吉利鋼管小茶几
W 60xD60xH51(cm)



29003 1003沙發組(1+2+3人)

單人沙發
W66xSD51xD80xSH43xH81(cm)
雙人沙發
W118xSD51xD80xSH43xH81(cm)
三人沙發
W174xSD51xD80xSH43xH81(cm)
2012大茶几
W127xD67xH52(cm)
2012小茶几
W 67xD67xH52(cm)



29004 如意沙發組(1+2+3人)

單人沙發
W63xSD51xD78xSH41xH87(cm)
雙人沙發
W115xSD51xD78xSH41xH87(cm)
三人沙發
W168xSD51xD78xSH41xH87(cm)
溫莎大茶几
W120xD60xH51(cm)
溫莎小茶几
W 60xD60xH51(cm)

29005 圓管沙發組(1+1+3人)

單人沙發
W65xSD52xD81xSH38xH82(cm)
三人沙發
W176xSD52xD81xSH38xH82(cm)
扁管大茶几
W125xD49xH51(cm)
扁管小茶几
W 44xD49xH51(cm)

30001 休閒沙發組(1+2+3人)

單人沙發
W65xSD52xD72xSH41xH76(cm)
雙人沙發
W125xSD52xD72xSH41xH76(cm)
三人沙發
W185xSD52xD72xSH41xH76(cm)
休閒大茶几
W120xD60xH51(cm)
休閒小茶几
W 60xD60xH51(cm)



30002 A17沙發組(1+2+3人)

單人沙發
W66xSD51xD77xSH37xH82(cm)
雙人沙發
W118xSD51xD77xSH37xH82(cm)
三人沙發
W172xSD51xD77xSH37xH82(cm)
俏麗大茶几
W120xD60xH52(cm)
俏麗小茶几
W 60xD60xH52(cm)



扶手收折功能

30003

豪華辦公網椅(氣壓+傾仰)
(氣壓+傾仰)(收折扶手)
W60xD58xH106.5-115(cm)



30004

豪華辦公網椅(氣壓+傾仰)
W腰靠
W60xD58xH106.5-115(cm)



30005

豪華辦公網椅(氣壓+傾仰)
W60xD58xH106.5-115(cm)



固定傾仰

30006

豪華辦公網椅(氣壓+傾仰)
W60xD58xH106.5-115(cm)



30007

豪優網椅(氣壓+傾仰)
W60xD58xH106.5-115(cm)



30008

豪優網椅(氣壓+傾仰)
W60xD58xH106.5-115(cm)



30009

豪優網椅(氣壓+傾仰)
(收折扶手)
W60xD58xH106.5-115(cm)



30010

豪雅網椅(氣壓+傾仰)
W59xD53xH115-123(cm)



30011

豪雅網椅(氣壓+傾仰)
W59xD53xH115-123(cm)



31001
W3網椅(氣壓+傾仰)
W61xD54xH98-107(cm)



31002
W3網椅(氣壓+傾仰)
W61xD54xH98-107(cm)



31003
5525網布椅(成型泡棉)
W62xD62xH100-108(cm)



31004
5526A網布椅(成型泡棉)
W62xD63xH89-97.5(cm)



31005
5526網布椅(成型泡棉)
W51xD63xH89-97.5(cm)



32001
N8塑殼鋼網椅(氣壓+傾仰)
W59xD51xH85-93(cm)



32002
N8塑殼鋼網椅(氣壓+傾仰)
W59xD51xH85-93(cm)



32003
N8塑殼鋼網椅(無扶手)(氣壓+傾仰)
W49xD51xH85-93(cm)



32004
鋼網全網辦公椅(氣壓+傾仰)
W61xD55xH87-95(cm)



32005
鋼網全網辦公椅(無扶手)(氣壓+傾仰)
W46xD55xH87-95(cm)

座背全網
特寫圖



31006
5519網布椅(成型泡棉)
W58xD56xH100-107(cm)



31007
5520A網布椅(成型泡棉)
W58xD56xH88-95(cm)



31008
5520A網布椅(成型泡棉)
W48xD56xH88-95(cm)



31009
5501網布椅(成型泡棉)
W59xD60xH99-107(cm)



31010
5502A網布椅(成型泡棉)
W59xD60xH84-91(cm)



32006
6505辦公椅(成型泡棉)
W59xD63xH104-111(cm)



32007
6506A辦公椅(成型泡棉)
W59xD59xH84-91(cm)



32008
6506辦公椅(成型泡棉)
W48xD59xH84-91(cm)



32009
9501A辦公椅(氣壓+傾仰)(成型泡棉)
W61xD53xH85-92(cm)



32010
9501辦公椅(氣壓+傾仰)(成型泡棉)
W49xD53xH85-92(cm)



31011
大鋼辦公網椅(氣壓+傾仰)(收折扶手)
W60xD61xH98.5-107(cm)



31012
大鋼辦公網椅(氣壓+傾仰)
W57xD46xH92-109(cm)



31013
大鋼辦公網椅(氣壓+傾仰)
W57xD46xH92-109(cm)



31014
小鋼辦公網椅(氣壓+傾仰)
W56xD50xH87-95.5(cm)



31015
小鋼辦公網椅(無扶手)(氣壓+傾仰)
W46xD50xH87-95.5(cm)



32011
N1厚墊網椅(氣壓+傾仰)(收折扶手)
W56xD50xH87-95.5(cm)



32012
N1厚墊網椅+W腰靠(氣壓+傾仰)
W56xD50xH87-95.5(cm)



32013
N1厚墊網椅(氣壓+傾仰)
W56xD50xH87-95.5(cm)



32014
N1厚墊網椅+腰靠(氣壓+傾仰)
W56xD50xH87-95.5(cm)



32015
N1厚墊網椅(氣壓+傾仰)
W46xD50xH87-95.5(cm)



31016
中型網椅(氣壓+傾仰)(收折扶手)
W61xD60xH100-108(cm)



31017
中型網椅(氣壓+傾仰)
W61xD60xH100-108(cm)



31018
小型鋼網椅(氣壓+傾仰)
W56xD48xH78-86(cm)



31019
小型鋼網椅(氣壓+傾仰)(收折扶手)
W56xD48xH78-86(cm)



31020
小型鋼網椅(氣壓+傾仰)
W46xD48xH78-86(cm)



32016
N2厚墊網椅(氣壓+傾仰)
W56xD50xH87-95.5(cm)



32017
N2厚墊網椅(氣壓+傾仰)
W56xD50xH87-95.5(cm)



32018
N2厚墊網椅(無扶手)(氣壓+傾仰)
W46xD50xH87-95.5(cm)



32019
中型靠背網椅(氣壓+傾仰)(收折扶手)
W61xD60xH100-108(cm)



32020
中型靠背網椅(氣壓+傾仰)
W61xD60xH100-108(cm)



33001 J40高背主管椅(黑皮)
(CH-30) W63xD57xH119(cm)

33002 W-6823黑網高背椅
(CH-21) W62xD50xH115(cm)

33003 684黑網高背扶手椅
(CH-17) W65xD52.5xH115-125(cm)

33004 Z-10黑網高背辦公椅
(CH-22) W65xD50xH120(cm)

33005 J46A白色活動式扶手椅
(CH-20) W57.5xD50xH115-125(cm)



33006 造型皮面主管椅
(CH-24) W67xD61xH118(cm)

33007 901辦公椅(橘色)
(CH-06) W60xD58xH115(cm)

33008 CN-W028A扶手腳踏椅
(CH-15) W52xD63xH130(cm)

33009 Q53白框灰網辦公椅
(S295-58) W56xD60xH97-106(cm)

33010 YS651網背座泡棉椅+上下手
(CH-04) W56xD46.5xH95-106(cm)



33011 630白色背網扶手椅
(CH-19) W70xD51xH116-126(cm)

33012 YS1048高背深灰黑條紋椅
(CH-07) W58xD55xH105(cm)

33013 YS1048高背白條紋椅
(CH-07-01) W58xD55xH105(cm)

33014 CN-W029C扶手小背椅
(CH-02) W52xD60xH125(cm)

33015 J78綠布含T扶手椅
(CH-18) W65.5xD49xH98-105(cm)



33016 J73淺綠灰手椅電鍍腳
(CH-25) W59xD59xH90(cm)

33017 8141辦公椅
(CH-08) W58xD55xH90(cm)

33018 葉子造型椅(橙背有扶手)
(CH-11) W63xD62xH94(cm)

33019 J91椅淺綠白扶手白腳椅
(CH-26) W48xD54xH87(cm)

33020 洽談椅
W60xD70xH102(cm)



34001 宿舍單人綜合床組
W205.5xD97xH216.5(cm)



34002 宿舍單人綜合床組
W205.5xD97xH216.5(cm)



34003 樓梯組(可單床使用或兩床共用)
訂製品



34004 三角圓雙人床(905)
W198.5xD92xH168(cm)



34005 三角圓雙人床(綠色)
W198.5xD92xH168(cm)



34006 三角圓雙人床(咖啡)
W198.5xD92xH168(cm)



34007 高級雙人床
W198.5xD97xH185.5(cm)



34008 小圓管雙人床(綠色)
W196xD93xH170.5(cm)



34009 圓管雙人床(綠色)
W198.5xD95xH169(cm)



34010 方管雙人床(綠色)
W198.5xD91.5xH168.5(cm)



34011 圓管雙人床
W198.5xD95xH169(cm)



34012 方管雙人床
W198.5xD91.5xH168.5(cm)



34013 折合鐵床
W185xD93.5xH36(cm)

收納：W93.5xD25.5xH119.5(cm)



餐桌、餐椅布套供應中

■金系列餐椅，採高級鋁合金管製造■



35001 金福祿宴會餐椅 W44xD56xSH46xH89(cm)
 35002 金圓頂宴會餐椅 W45.5xD57.5xSH46xH92(cm)
 35003 金勇士宴會餐椅 W44xD55.5xSH46xH92(cm)
 35004 金登圓宴會餐椅 W44xD57xSH46xH96(cm)
 35005 金元寶宴會餐椅 W44xD58.5xSH46xH90.5(cm)



35006 409閃銀扁管餐桌
 35007 巧思餐椅
 35008 摩洛哥餐椅
 35009 303餐桌
 35010 名流餐椅



35011 702造型餐桌
 35012 伯爵餐椅
 35013 餐桌
 35014 丹比餐椅



36001 華麗餐椅 W41xD58xSH47.5xH97(cm)
 36002 約翰餐椅 W45xD63xSH49xH93(cm)
 36003 藍天餐椅 W45xD59xSH49xH93(cm)
 36004 新路易士餐椅 W46xD63xSH49xH105(cm)
 36005 現代餐椅 W42xD55.5xSH46xH96(cm)



36006 丹比餐椅(烤漆腳) W45xD58xSH46.5xH96(cm)
 36007 丹寧高背餐椅 W45xD54xSH46.5xH95(cm)
 36008 丹寧低背餐椅 W45xD55xSH46.5xH78(cm)
 36009 丹佐低背餐椅 W45xD55xSH46.5xH78(cm)



36010 高背猛士餐椅 W42xD58xSH46.5xH92(cm)
 36011 帝王椅 W42xD59xSH46.5xH98(cm)
 36012 波羅餐椅(電鍍) W47.5xD56xSH45.3xH85(cm)
 36013 高級方立餐椅(烤黑) W44xD52xSH45xH88(cm)
 36014 排骨餐椅



36015 鋼製單人椅 W42xD30xH46(cm)
 36016 鋼製單人椅 W42xD30xH46(cm)
 36017 鋼製雙人椅 W94xD30xH46(cm)
 36018 鋼製雙人椅 W94xD30xH46(cm)
 36019 雙人板凳(烤黑) W104xD29xH47(cm)



37001 三尺免螺絲角鋼架
W90xD45xH152(cm)
W90xD60xH152(cm)



37002 四尺免螺絲角鋼架
W120xD45xH152(cm)
W120xD60xH152(cm)
W120xD75xH152(cm)



37003 五尺免螺絲角鋼架
W150xD45xH152(cm)
W150xD60xH152(cm)
W150xD75xH152(cm)



37004 六尺免螺絲角鋼架
W180xD45xH152(cm)
W180xD60xH152(cm)
W180xD75xH152(cm)



37005 三尺免螺絲角鋼架
W90xD45xH182(cm)
W90xD60xH182(cm)



37006 四尺免螺絲角鋼架
W120xD45xH182(cm)
W120xD60xH182(cm)
W120xD75xH182(cm)



37007 五尺免螺絲角鋼架
W150xD45xH182(cm)
W150xD60xH182(cm)
W150xD75xH182(cm)



37008 六尺免螺絲角鋼架
W180xD45xH182(cm)
W180xD60xH182(cm)
W180xD75xH182(cm)



37009 三尺免螺絲角鋼架
W90xD45xH212.8(cm)
W90xD60xH212.8(cm)



37010 四尺免螺絲角鋼架
W120xD45xH212.8(cm)
W120xD60xH212.8(cm)
W120xD75xH212.8(cm)



37011 五尺免螺絲角鋼架
W150xD45xH212.8(cm)
W150xD60xH212.8(cm)
W150xD75xH212.8(cm)



37012 六尺免螺絲角鋼架
W180xD45xH212.8(cm)
W180xD60xH212.8(cm)
W180xD75xH212.8(cm)



37013 三尺免螺絲角鋼架
W90xD45xH243.2(cm)
W90xD60xH243.2(cm)



37014 四尺免螺絲角鋼架
W120xD45xH243.2(cm)
W120xD60xH243.2(cm)
W120xD75xH243.2(cm)



37015 五尺免螺絲角鋼架
W150xD45xH243.2(cm)
W150xD60xH243.2(cm)
W150xD75xH243.2(cm)



37016 六尺免螺絲角鋼架
W180xD45xH243.2(cm)
W180xD60xH243.2(cm)
W180xD75xH243.2(cm)



橫樑



立柱腳套



組裝示意圖



衣架吊衣桿



橫樑可訂製四孔嵌入式電源插座



補強桿

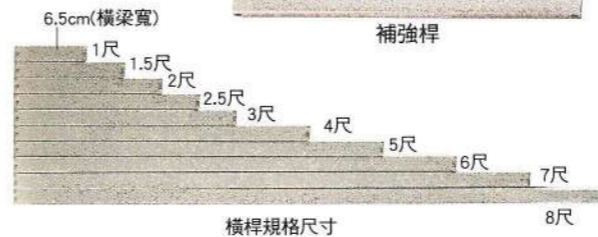

38001 移動式衣架
W120xD60xH190.8(cm)



38002 雙層衣架
W90xD60xH212.8(cm)



38003 衣架
W90xD60xH212.8(cm)



38004 厚墊置物吧檯椅
W39.5xD29.5xH75(cm)



38005 L型置物吧檯椅
W39.5xD48xSH75xH109(cm)



38006 伯爵高吧檯椅
W42xD58xSH72xH110(cm)



38007 723吧檯桌
Φ60xH105(cm)



38009 B302-B吧檯椅
SH61-75(cm)



38010 雅士電鍍吧椅
SH61-75(cm)



38011 欣圓黑/圓盤電金低吧椅
SH50-63(cm)



38012 美樂電鍍雙圈吧檯椅(16)
SH60-74(cm)



38013 B316A吧椅
SH72-86(cm)



38014 810固定吧檯椅
SH45(cm)



38015 折凳椅
Φ30xH45(cm)



38016 817吧檯椅



38017 厚墊吧檯椅



38018 厚墊烤黑雙圈吧檯椅
SH60-74(cm)



38019 厚墊電鍍四爪踏圈吧檯椅
座Φ30xSH58-70(cm)



39001 二人口字腳公共排椅

39002 三人口字腳公共排椅

39003 四人口字腳公共排椅



39004 二人T型腳公共排椅

39005 三人T型腳公共排椅

39006 四人T型腳公共排椅



39007 二人口字腳公共排椅

39008 三人口字腳公共排椅

39009 四人口字腳公共排椅



39010 二人T型腳公共排椅

39011 三人T型腳公共排椅

39012 四人T型腳公共排椅



39013 環保無背彩虹公園椅
W120xD40xH43(cm)



39014 環保可調升降課桌椅
課桌：W65xD45xH75(cm)
課椅：W42xD45xH80(cm)



39015 多用途單人椅
W45xD46xH80(cm)



39016 環保單人椅
W50xD50xH85(cm)



39017 鐵板凳



39018 環保工作椅
椅面Φ35xH40-53(cm)



39019 環保工作椅
椅面Φ35xH50-55(cm)



39020 環保工作椅
椅面Φ35xH50-62(cm)



39021 環保圓椅
椅面Φ35xH48(cm)



39022 環保圓椅
椅面Φ35xH48(cm)



39023 環保會議桌(重量10KG)
W180xD60xH74(cm)



39024 環保會議桌(含層板/重量12KG)
W180xD60xH74(cm)



40001 A4單排1小1中抽
J-A4-001S1M
W26xD34.5xH17.3(cm)



40002 A4單排3小抽
J-A4-003S
W26xD34.5xH17.3(cm)



40003 A4單排3中抽
J-A4-003M
W26xD34.5xH30.6(cm)



40004 A4單排2中抽
J-A4-002M
W26xD34.5xH21.7(cm)



40005 A4單排2小1中抽
J-A4-002S1M
W26xD34.5xH21.7(cm)



40006 A4單排4小抽
J-A4-004S
W26xD34.5xH21.7(cm)



40007 A4單排10小抽
J-A4-010S
W27.7xD34.5xH48.3(cm)



40008 A4單排5中抽
J-A4-005M
W27.7xD34.5xH48.3(cm)



40009 A4單排4小3中抽
J-A4-004S3M
W27.7xD34.5xH48.3(cm)



40010 A4雙排右三小3中抽
J-A4-DN3S3M
W53.5xD34.5xH44(cm)



40011 A4單排6小抽
J-A4-006S
W26xD34.5xH30.6(cm)



40012 A4單排8中抽
J-A4-008M
W27.8xD34.5xH74(cm)



40013 A4單排1小7中抽
J-A4-001S7M
W27.7xD34.5xH74(cm)

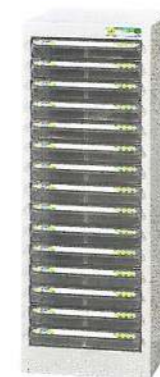

40014 A4單排15小抽
J-A4-015S
W27.7xD34.5xH74(cm)



40015 A4單排6小3中抽
J-A4-006S3M
W27.7xD34.5xH57.4(cm)



40016 A4單排4小1中抽
J-A4-004S1M
W26xD34.5xH30.6(cm)

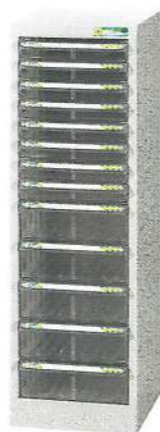

40017 A4單排8小5中抽
J-A4-008S5M
W27.7xD34.5xH88(cm)



40018 A4單排18小抽
J-A4-018S
W27.7xD34.5xH88(cm)

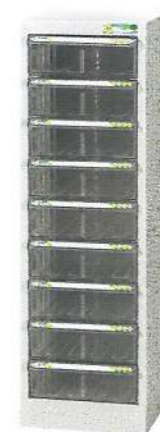

40019 A4單排9中抽
J-A4-009M
W27.7xD34.5xH88(cm)

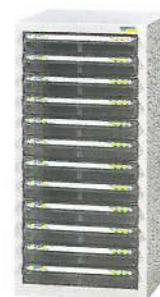

40020 A4單排12小抽
J-A4-012S
W27.7xD34.5xH57.4(cm)



40021 A4單排6中抽
J-A4-006M
W27.7xD34.5xH57.4(cm)



41001 B4單排2小1中抽 J-B4-O02S1M W29.4xD40.5xH21.7(cm)
41002 B4單排4小抽 J-B4-O04S W29.4xD40.5xH21.7(cm)
41003 B4單排3中抽 J-B4-O03M W29.4xD40.5xH30.4(cm)
41004 B4單排4小1中抽 J-B4-O04S1M W29.4xD40.5xH30.4(cm)
41005 B4單排6小抽 J-B4-O06S W29.4xD40.5xH30.4(cm)
41006 B4單排5中抽 J-B4-O05M W31.3xD40.5xH48.3(cm)



B4中抽 B4小抽

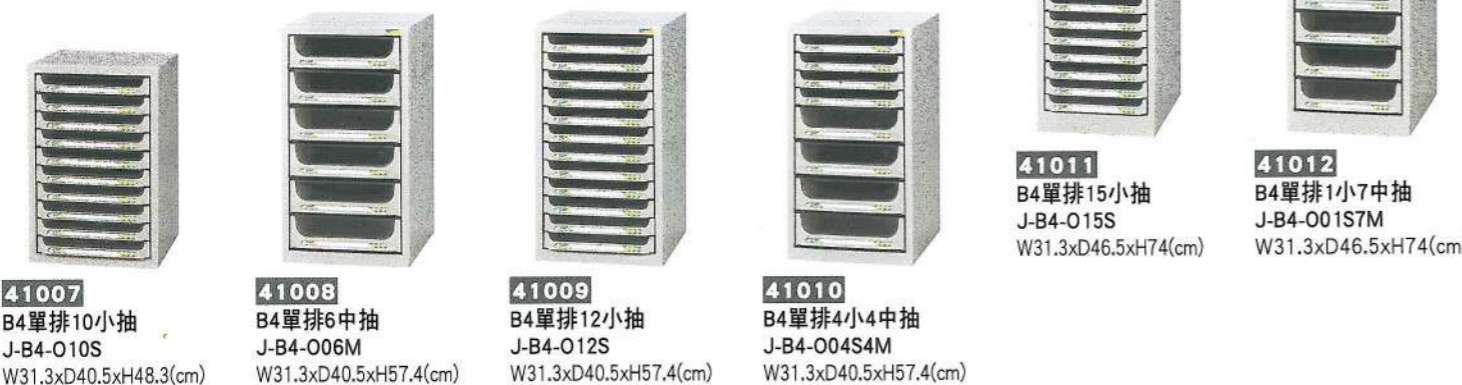

41007 B4單排10小抽 J-B4-O10S W31.3xD40.5xH48.3(cm)
41008 B4單排6中抽 J-B4-O06M W31.3xD40.5xH57.4(cm)
41009 B4單排12小抽 J-B4-O12S W31.3xD40.5xH57.4(cm)
41010 B4單排4小4中抽 J-B4-O04S4M W31.3xD40.5xH57.4(cm)
41011 B4單排15小抽 J-B4-O15S W31.3xD46.5xH74(cm)
41012 B4單排1小7中抽 J-B4-O01S7M W31.3xD46.5xH74(cm)



41013 B4三排3小21中抽 J-B4-T03S21M W90xD46.5xH74(cm)
41014 B4雙排2小14中抽 J-B4-D02S14M W60.3xD46.5xH74(cm)
41015 B4雙排30小抽 J-B4-D30S W60.3xD46.5xH74(cm)
41016 B4單排22小抽 J-B4-O22S W31.3xD46.5xH106.2(cm)
41017 B4單排6小8中抽 J-B4-O06S8M W31.3xD46.5xH106.2(cm)



41018 B4三排33中抽 J-B4-T33M W90xD46.5xH106.2(cm)
41019 B4三排66小抽 J-B4-T66S W90xD46.5xH106.2(cm)
41020 B4雙排22中抽 J-B4-D22M W60.3xD46.5xH106.2(cm)
41021 B4雙排44小抽 J-B4-D44S W60.3xD46.5xH106.2(cm)
41022 B4單排11中抽 J-B4-O11M W31.3xD46.5xH106.2(cm)



42001 A4雙排10中抽 J-A4-D10M W53.5xD34.5xH48.3(cm)
42002 A4雙排20小抽 J-A4-D20S W53.5xD34.5xH48.3(cm)
42003 A4雙排右9小抽 J-A4-DN9S W53.5xD34.5xH44(cm)
A4中抽(插板另購) A4小抽(插板另購)



42004 A4雙排30小抽 J-A4-D30S W53.5xD34.5xH74(cm)
42005 A4雙排2小14中抽 J-A4-D02S14M W53.5xD34.5xH74(cm)
42006 A4三排3小21中抽 J-A4-T03S21M W79xD34.5xH74(cm)



42007 A4單排16中抽 J-A4-O16M W27.7xD34.5xH149(cm)
42008 A4單排32小抽 J-A4-O32S W27.7xD34.5xH149(cm)



42009 A4雙排18中抽 J-A4-D18M W53.5xD34.5xH88(cm)
42010 A4雙排36小抽 J-A4-D36S W53.5xD34.5xH88(cm)
42011 A4雙排12小12中抽 J-A4-D12S12M W53.5xD34.5xH88(cm)
42012 A4三排45小抽 J-A4-T45S W79xD34.5xH74(cm)



42013 A4三排27中抽 J-A4-T27M W79xD34.5xH88(cm)
42014 A4三排54小抽 J-A4-T54S W79xD34.5xH88(cm)
42015 A4三排33中抽 J-A4-T33M W79xD34.5xH106.2(cm)
42016 A4三排66小抽 J-A4-T66S W79xD34.5xH106.2(cm)



43002 B4三排中空4小6中抽
J-B4-TN16SM
寬90x深46.5x高41(cm)



43001 A4 左5中右10小抽
J-A4-D10S5M
寬53.5x深34.5x高48.4(cm)



43003 B4三排中空16小抽
J-B4-TN16S
寬90x深46.5x高41(cm)



43004 A4單排16小抽
J-A4-O16S
寬27.8x深34.3x高74(cm)



43005 B4單排16中抽
J-B4-O16M
寬31.3x深40.5x高149(cm)



43006 B4單排32小抽
J-B4-O32S
寬31.3x深40.5x高149(cm)



43007 3尺A4單開門18小抽
寬88x深41.5x高88(cm)



43008 3尺A4單開門9中抽
寬88x深41.5x高88(cm)



43009 4尺B4鐵拉門9中抽
寬118x深41.5x高88(cm)



43010 4尺B4鐵拉門18小抽
寬118x深41.5x高88(cm)

契約條款注意事項

◆契約條款：六、訂購方式：

(六)各訂購機關每次訂購金額不得少於新臺幣30,000元。如訂購金額低於新臺幣30,000元者，其運送所需費用由訂購機關與立約商另行議定。單一訂單未達上述最低訂購金額者，立約商得不接受訂購。

◆契約條款：七、交貨地點：

(二)訂購機關指定之交貨地點未在地面樓層且無電梯可供搬運時，每上下一樓層按各該樓層運交品項金額3%核計搬運費。利用電梯搬運時，不計樓層數按運交品項金額3%核計搬運費。

(三)訂購機關如為山地偏僻地區時，得由立約商向訂購機關酌加收運費。30個臺灣地區山地(原住民)鄉為限。未納入山地偏遠地區之花蓮、台東地區，比照前述山地偏遠地區之規定辦理，惟運費最多以該訂單總價金額5%為限(總價金額計算至整數，元以下4捨5入)。至於平地偏遠地區，訂購機關如屬領有偏僻地加給之地區者，得比照上述山地偏僻地區之規定辦理。

◆契約條款：八、交貨期限與驗收：

(一)2.原有物品如需拆除搬移費用可與訂購機關議定，上述費用議定後於訂購單上註明逕洽立約商辦理。公文櫃如需聯結固定時每單張可另加價200元上限。

◆台灣銀行股份有限公司辦理中央政府各機關、學校、國營事業辦理辦公椅桌、椅、電腦桌、衣櫃、公文櫃、檔案櫃、屏風採購之契約合格廠商產品目錄總覽。

◆本案並適用於軍、公、教各直轄市、縣市、議會；鄉鎮區等機關之採購標準。



43011 2大屜卡片箱(十輪)
寬46x深62x高74(cm)



43012 3大屜卡片箱(十輪)
寬46x深62x高106(cm)



43013 4大屜卡片箱(十輪)
寬46x深62x高140(cm)